



Pneumatically operated 2/2 way Valve

- Stainless steel or brass body with threaded connection
- High service life
- Compact design
- Variant for steam applications available



Product variants described in the data sheet may differ from the product presentation and description.

Can be combined with

- | | |
|-------------------------------------------------------------------------------------|--------------------------------------------------------------------------------------------|
|  | Type 6014 ▶
Plunger valve 3/2 way direct-acting |
|  | Type 8640 ▶
Customized Pneumatic Systems Solutions for the Processing Industries |
|  | Type 6012 ▶
Plunger valve 3/2 way direct-acting |
|  | Type 8644 ▶
Remote Process Actuation Control System AirLINE |
|  | Type 8311 ▶
Pressure measuring device / Switch |

Type description

The externally piloted 2-way valve is operated by a diaphragm actuator. A double spindle seal guarantees high tightness and a high service life. The compact actuator housing is made out of chemical resistant plastic and ideal for customer specific multifunction block solutions.

This low maintenance and robust valve can be supplemented by a large accessory program.

Table of contents

1. General technical data	3
2. Circuit functions	3
3. Approvals	4
4. Materials	4
4.1. Chemical Resistance Chart – Bürkert resistApp.....	4
4.2. Material specifications	4
5. Dimensions	5
6. Performance specifications	6
6.1. Pressure range	6
6.2. Operating pressure/pilot pressure diagram	6
7. Ordering information	6
7.1. Bürkert eShop – Easy ordering and quick delivery.....	6
7.2. Bürkert product filter.....	6
7.3. Ordering chart.....	7



1. General technical data

Product properties	
Dimensions	Detailed information can be found in chapter "5. Dimensions" on page 5.
Material	
Body	Brass, stainless steel
Inner part valve	Stainless steel
Actuator	Epoxy resin
Seal	NBR, FKM, PTFE/FKM, EPDM, PTFE/EPDM
Orifice	DN 10...DN 25
Performance data	
Pilot pressure	Detailed information can be found in chapter "6. Performance specifications" on page 6.
Medium data	
Medium	
With NBR	Neutral medium, e.g. compressed air, town gas, water, hydraulic oil
With FKM	Per-solution, oxygen, hot air
With EPDM	Oil and fat-free medium, e.g. hot water, alkaline washing and bleaching lyes
With PTFE/EPDM (PTFE seal with EPDM O-ring)	Oil and fat-free medium, e.g. hot water and steam
With PTFE/FKM (PTFE seal with FKM O-ring)	Hot oils, hydrocarbonated water, aromatics and steam
Medium temperature	
With NBR	-10 °C...+90 °C
With FKM	-10 °C...+100 °C
With EPDM	-10 °C...+100 °C
With PTFE/EPDM	-10 °C...+140 °C
With PTFE/FKM	-10 °C...+140 °C
Viscosity	Max. 100 mm ² /s
Control medium	Neutral gases and liquids, in particular air, water, hydraulic liquids up to max. +90 °C
Environment and installation	
Ambient temperature	-10 °C...+90 °C
Installation position	As required, preferably with actuator upright

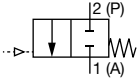
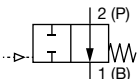
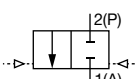
2. Circuit functions

Control function	Description
	CF: A, pneumatically operated on/off valve 2/2 way Flow direction below seat Normally closed by spring force
	CF: B, pneumatically operated on/off valve 2/2 way Flow direction above seat Normally opened by spring force
	CF: I, pneumatically operated on/off valve on either side 2/2 way Flow direction below seat Normally closed (without spring)

3. Approvals

Approvals	Description
 	<p>Explosion protection As category 2 device suitable for zone 1/21 and zone 2/22 (option)</p> <p>ATEX: II 2G Ex h IIC T4 Gb II 2D Ex h IIIC T135 °C Db</p> <p>IECEX: Ex h IIC T4 Gb Ex h IIIC T135 °C Db</p>

4. Materials

4.1. Chemical Resistance Chart – Bürkert resistApp

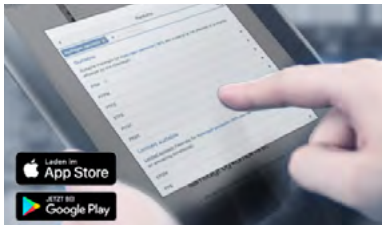

Bürkert resistApp – Chemical Resistance Chart

You want to ensure the reliability and durability of the materials in your individual application case? Verify your combination of media and materials on our website or in our resistApp.

Start Chemical Resistance Check

4.2. Material specifications

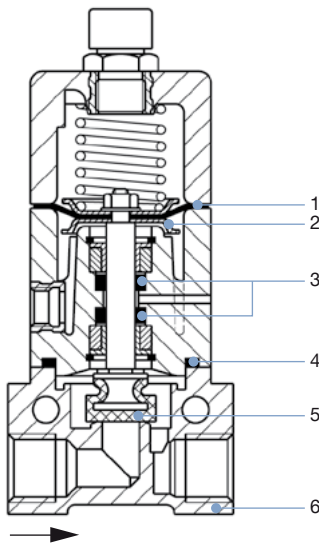

No.	Element	Material
1	Control diaphragm	FKM, PTFE
2	Spring plate	Stainless steel 1.4301
3	Lip seal	NBR, EPDM, FKM, PTFE
4	O-Ring	NBR, EPDM, FKM
5	Seal	NBR, EPDM, FKM, PTFE
6	Body	Brass, stainless steel 1.4581

5. Dimensions

Note:

- Upper pilot air port only for CFB and CFI
- Dimensions in mm

DN 10/DN 12

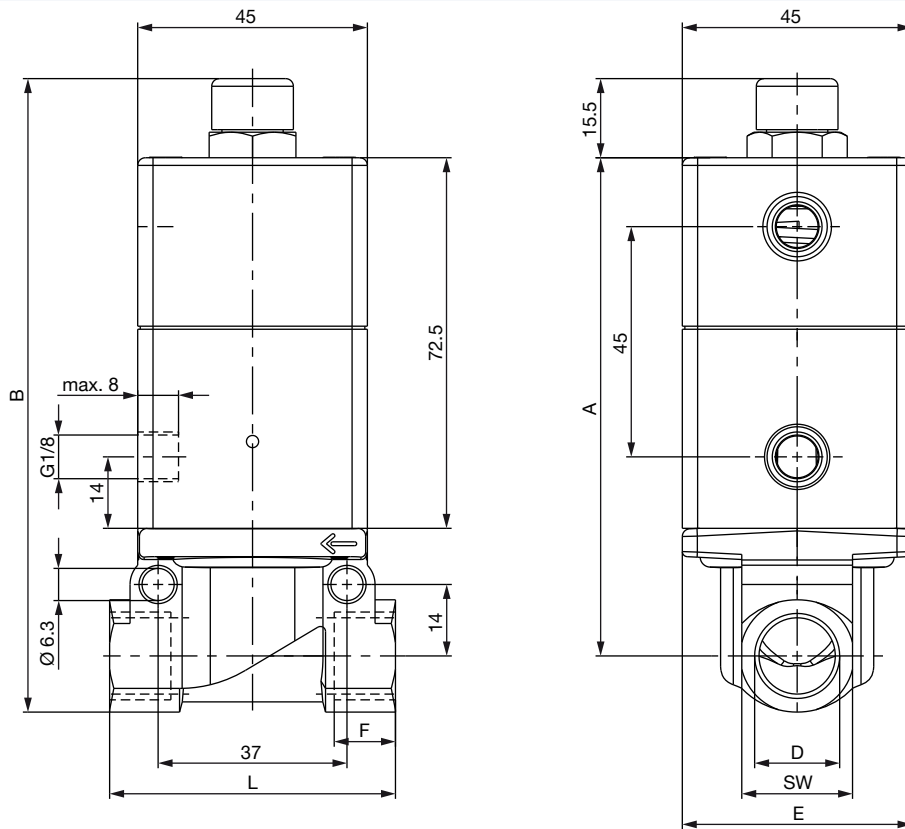

DN 20/DN 25

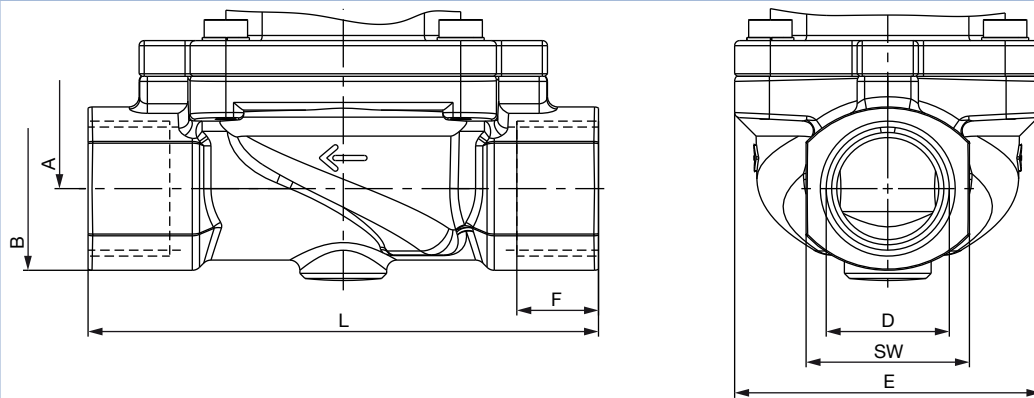

Orifice	D	A	B	E	F	L	SW
10	G 3/8	97.5	124	45	12	56	22
12	G 1/2	96.5	127.5	40	14	74.5	27
20	G 3/4	109.5	141	60	16	100	32
25	G 1	114	150	70	18	115	41

6. Performance specifications

6.1. Pressure range

Orifice	K _v value water	Port connection	Operating pressure max.			Control pressure max.	Weight
			CF: A normal spring	CF: A reinforced spring	CF: B and I normal spring		
[mm]	[m ³ /h] ^{1.)}		[bar] ^{2.)}	[bar] ^{2.)}	[bar] ^{2.)}	[bar] ^{2.)}	[kg]
10	1.0	G 3/8	5	10	10	6	0.5
12	2.1	G 1/2	3.5	6	10	6	0.6
20	6.5	G 3/4	–	1.5	1.5	6	1.0
25	10.0	G 1	–	1	1	6	1.4

1.) Flow rate K_v value water: measured at +20 °C, 1 bar pressure at valve inlet and free outlet

2.) Pressure data: Measured as overpressure to the atmospheric pressure

6.2. Operating pressure/pilot pressure diagram

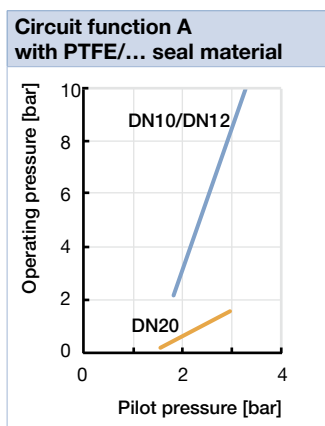

7. Ordering information

7.1. Bürkert eShop – Easy ordering and quick delivery



Bürkert eShop – Easy ordering and fast delivery

You want to find your desired Bürkert product or spare part quickly and order directly? Our online shop is available for you 24/7. Sign up and enjoy all the benefits.

[Order online now](#)

7.2. Bürkert product filter



Bürkert product filter – Get quickly to the right product



































You want to select products comfortably based on your technical requirements? Use the Bürkert product filter and find suitable articles for your application quickly and easily.

[Try out our product filter](#)

7.3. Ordering chart

Note:

Valves with threaded connection

Circuit function	Orifice	Port connection	K _v value water [m ³ /h] ^{1.)}	Pressure spring actuator	Operating pressure max. [bar] ^{2.)}	Seal material	Article no.
	[mm]						
Brass body							
A	10	G ¾	1.0	normal	5	EPDM	026059 
						FKM	026257 
						NBR	026287 
				reinforced	10	EPDM	027400 
						FKM	026459 
						NBR	027643 
	12	G ½	2.1	normal	3.5	EPDM	027545 
						FKM	026088 
						NBR	027734 
				reinforced	6	EPDM	026079 
						FKM	027926 
						NBR	027991 
	20	G ¾	6.5	reinforced	1.5	EPDM	028211 
						FKM	028046 
						NBR	028072 
25	G 1	10.0	reinforced	1	EPDM	029106 	
					FKM	028410 	
					NBR	028071 	
B	10	G ¾	1.0	normal	10	EPDM	026812 
						FKM	027891 
						NBR	026290 
	12	G ½	2.1	normal	10	EPDM	027988 
						FKM	026715 
						NBR	026298 
	20	G ¾	6.5	normal	1.5	EPDM	028557 
						FKM	027773 
						NBR	027639 
Stainless steel body							
A	10	G ½	1.0	reinforced	10	EPDM	167814 
						NBR	228680 
	12	G ½	2.1	normal	3.5	FKM	028011 
						reinforced	6
					FKM	028762 	
B	12	G ½	2.1	normal	10	FKM	029007 
						PTFE/FKM	027558 
						PTFE/EPDM	028496 

 1.) Flow rate K_v value water: measured at +20 °C, 1 bar pressure at valve inlet and free outlet

2.) Pressure data: Measured as overpressure to the atmospheric pressure

Bürkert – Close to You

For up-to-date addresses
please visit us at
www.burkert.com

DTS 1000010919 EN Version: H Status: RL (released | freigegeben | validé) printed: 08.03.2021

